



GARLANDO SPA

Via Regione Piemonte, 32 - Zona Industriale D1

15068 - Pozzolo Formigaro (AL) - Italy

www.toorx.it - info@toorx.it

Cod : GRLDTOORXXWAPAP



TOORX
FITNESS IN MOTION

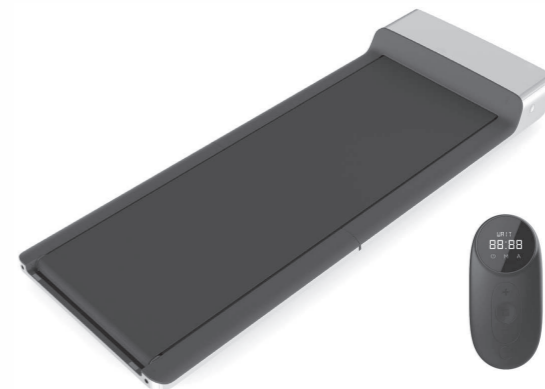

WalkingPad

with display on the remote control

User Manual

WARNING

Electric shock hazard, where the appliance is used without the earth connection.

This appliance is not intended for use by persons (including children) with reduced physical, sensory or mental capabilities, or lack of experience and knowledge, unless they have been given supervision or instruction concerning use of the appliance by a person responsible for their safety. Children should be supervised to ensure that they do not play with the appliance.

To reduce the risk of personal injury, read and understand all the instructions before using this product.

Content

1. Product and Accessories	02
2. Function schematic diagram	03
3. Guide for initial operation	07
4. Learn to use WalkingPad	09
5. Safety Notice	13
6. Maintenance and Service	16
7. Trademark and Legal Declaration	17
8. Replacement and Disposal	18

Welcome to use

Thank you for choosing the WalkingPad Walking device, hereinafter referred to as a WalkingPad, which possess various advantages including exquisite, foldable, innovative integral design. From now on, enjoy the quality life of walking at home.

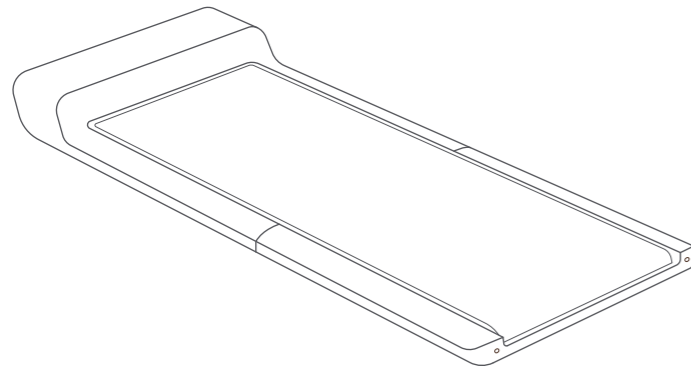

Performance & indicators	Detailed parameters
Detailed parameters	1432 x547 x129mm 56.5" x 21.5" x 5"
Folding dimensions	822 x 547 x 129 mm 32.5" x 21.5" x 5"
Walking Area	1200 x 415 mm 47" x 16.5"
Gross weight	31 kg / 68 lbs
Net weight	28 kg / 62 lbs
Maximum load	100 kg / 220 lbs
Applicable age	14 ~ 60 years old
Applicable height	Unlimited
Minimum speed	0.5 km/hr 0.5 mi/hr
Maximum speed	6 km/hr 3.75 mi/hr
Power Input	746 W
Frequency	60 Hz
Rated voltage	220 - 240 V ~
Sport mode	Standby mode/ Manual mode/ Automatic mode

01 Product and Accessories

Please carefully check whether the contents of the package are complete and intact. If there is any missing or damaged, please contact the seller.

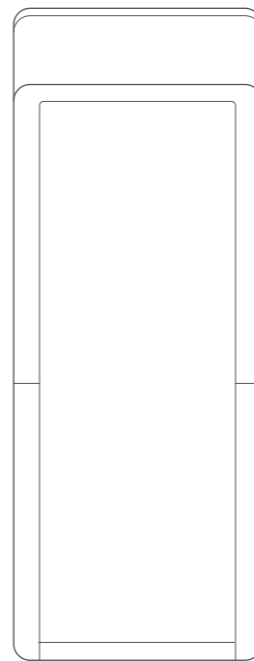

Main Product

Parts



Power Cable



Remote Controller



Lanyard



Wrench



Silicone Oil

Other accessories



User Manual

02 Function schematic diagram

1. Product main body



02 Function schematic diagram

2. Introduction of the function of the indicator panel

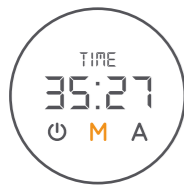

Display Time



Display Speed



Display Distance

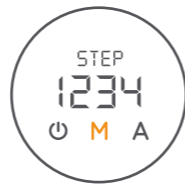

Display Steps



Standby Mode



Manual Mode



Automatic Mode

3. WalkingPad remote control

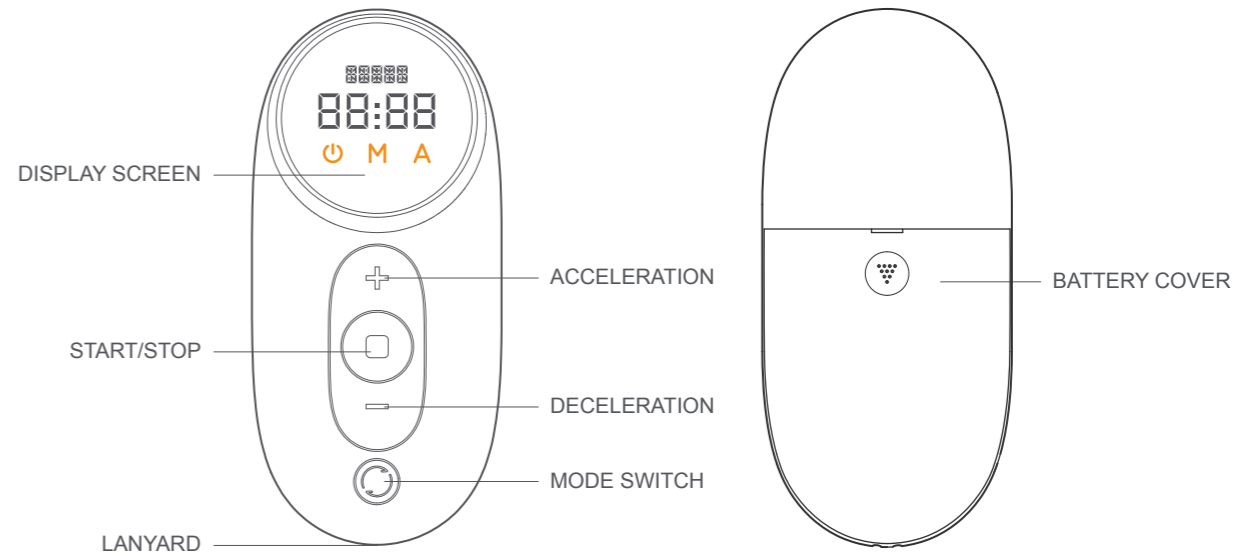

03 Guide for initial operation

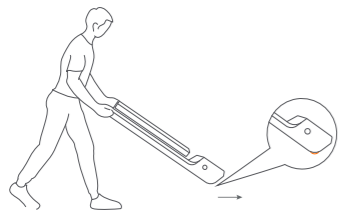

1. Choose flat ground to place the WalkingPad. It is forbidden to place it on thick and soft cushion. Please note: Don't connect the power before the WalkingPad is fully unfolded.



2. Unfold the WalkingPad slowly and press it down to completely flat.

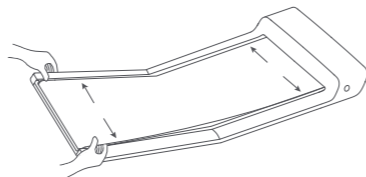

3. Check and adjust the walking belt to make sure it's centered.

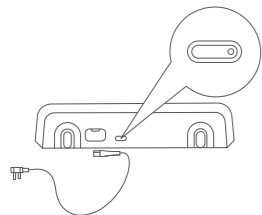

4. Connect the power cord and press the button to switch on.



5. Search "WalkingPad" App from Apple Store or Google Play and complete installation.

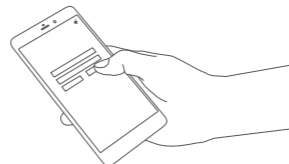

6. Open the App, follow the prompts to set up the device.



7. Enter novice guide.

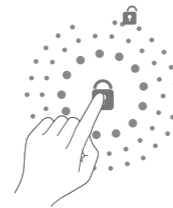

8. Complete Novice Guide to unlock all Functions (maximum speed 3.75 mi/hr). Otherwise the speed limit remains at 1.75 mi/hr.

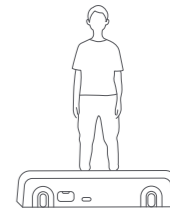

9. Start to use the WalkingPad.

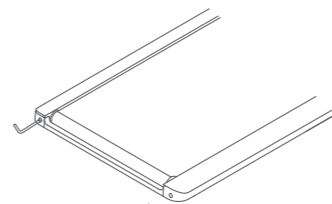

10. If the belt deviates from the orbit in use, please adjust properly. SEE: 06 Maintenance and service.

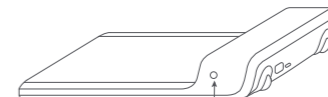

Mode Switch

11. Short press: return to the previous mode. Long press: switch to Standby mode.

04 Learn to use WalkingPad

1. Mode instruction

U Standby Mode
Light of the Standby mode is on;
Motor and sensor stop responding.

M Manual Mode
Light of the manual mode is on;
Control the speed through the remote control or APP.

A Automatic Mode
Light of the automatic mode is on;
Speed is automatically controlled by intelligent algorithm.
It follows the speed of walking.

2. Instructions of the standby mode control



Standby Mode

The motor and sensor stop responding in this mode to prevent nonusers from accidentally triggering the WalkingPad.



Mode Switch
Short press: return to the previous mode.

3. Instructions of manual mode control (primary mode)

M

Manual Mode

In this mode, the speed of the WalkingPad can be controlled by the remote control. It is recommended that beginners use the manual mode first and then use the automatic mode after being skilled in using the WalkingPad. The manual mode is controlled by remote control by default, that is, the START/STOP button of the remote control is used to start or stop the WalkingPad, which can be modified in the client "Personalized".



ACCELERATION
Short press: increase speed by 0.25 mi.

START/STOP
Short press: Start or Stop the WalkingPad.

DECELERATION
Short press: reduce speed by 0.25 mi.

MODE SWITCH
Short press: switch to automatic mode.
Long press: switch to Standby mode.

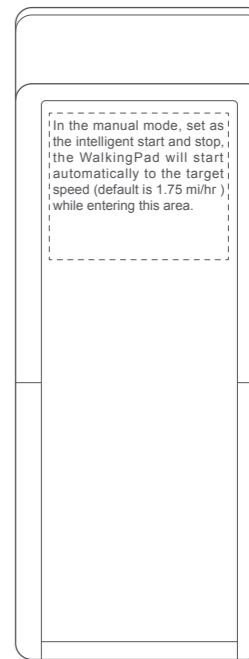

04 Learn to use WalkingPad

4. Description of automatic mode control (advance mode)

A

Automatic mode

This is a challenging and higher class mode. User can walk on the WalkingPad completely out of remote controller. We only recommend those who have good sports skills or walking machine experience to take the challenge.



Short press: stop the WalkingPad.

Mode Switch:
Short press: switch to manual mode.
Long press: switch to Standby mode.

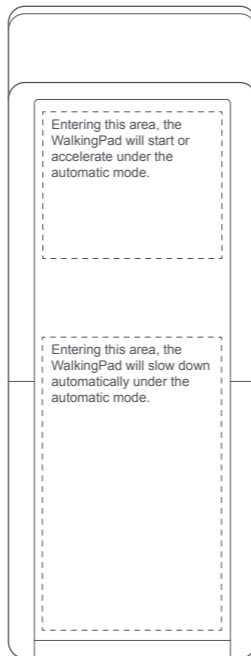

5. Remote Controller Notice

If the remote controller has no response or you change a new one, the remote controller and walking device need to re-establish communication.

Remote control pairing method:

Restart the WalkingPad, press and hold down the mode switch button on the remote control immediately, hearing the sound of "Beep" indicates the success of pairing. Note: During the operation, the remote control should be close to the WalkingPad.

6. Error code

The error code is off when the walking machine is working normally. While error occurs, the display panel of remote shows the error code.

E01: Drive communication fault;

E02: Motor abnormalities;

E05: Overcurrent protection;

E06: Motor Protection;

E08: Sensor Fault;

E09: Controller connection failure;

E10: High temperature protection, automatic recovery after the end of countdown;

E11: Overload protection, please add lubricating oil, and resume automatically after countdown.

05 Safety Notice

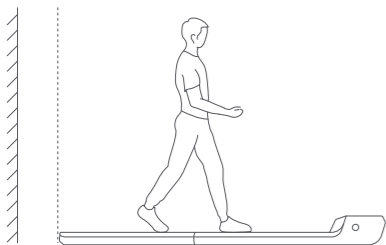

⚠ Please keep a rear distance of 1000 mm or more.

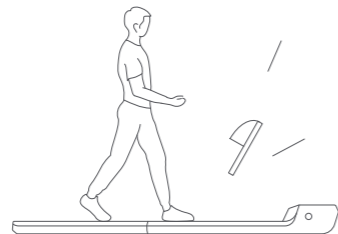

⚠ Please choose sport shoes.



⚠ Please do not stand up on the walking machine when it is under auto calibration situation.

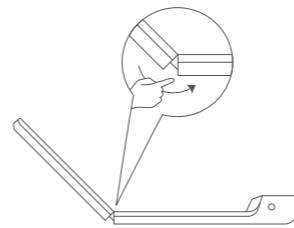

⚠ Anti-pinch.

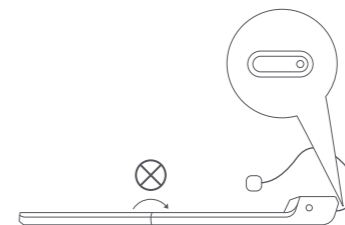

⊗ Turn the power off before fold up the WalkingPad.

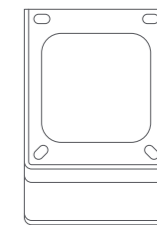

⊗ Prohibition of vertical placement.

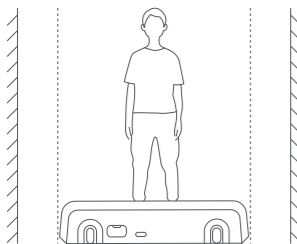

⚠ Please keep a distance of 500 mm or more for both sides.

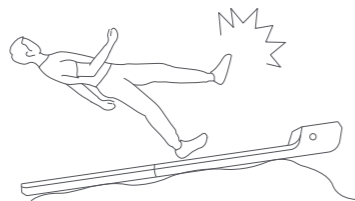

⊗ Using on uneven ground is prohibited.



⊗ It is strictly prohibited to walk up and down the walking machine when running.

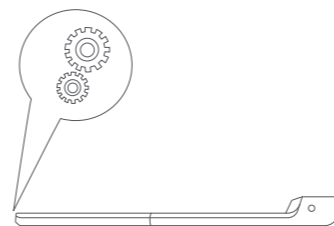

⚠ Anti-involved, please do not trample.

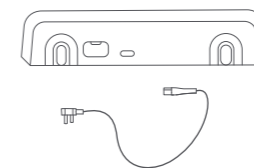

⚠ Please pull out the plug when you are not using it.

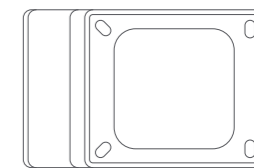

⊗ Prohibition of lateral placement.

05 Safety Notice

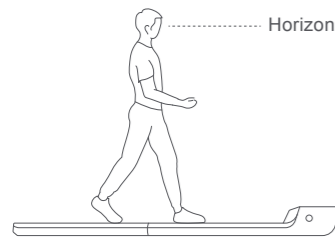

! Please keep your sight horizontal to avoid dizziness.

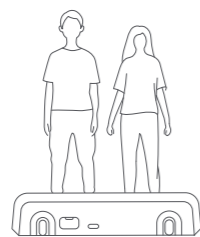

⊗ More than one person on the WalkingPad is prohibited.

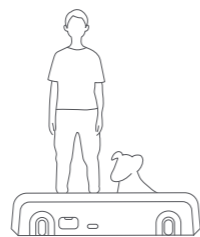

⊗ Using machine with pet is prohibited.

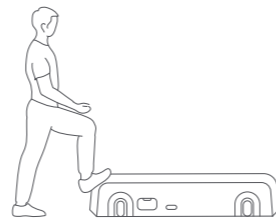

⊗ Trampling the machine head is prohibited.

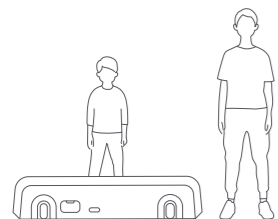

! Children should be supervised to ensure that they do not play with the WalkingPad.

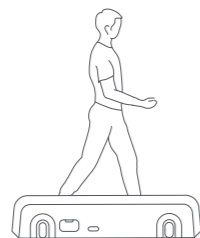

⊗ Walking sideways on the machine is prohibited.

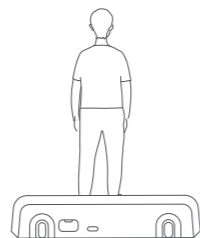

⊗ Walking backwards on the machine is prohibited.



! Please do not use the walking machine if you are aged people or pregnant women.

06 Maintenance and Service

1. Clean the walking machine

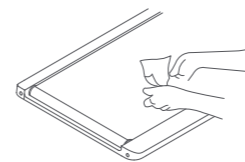

- Turn off the machine and unplug the power cord.
- Add several drops of detergent on cotton rag or towel. Don't pour the detergent on the belt directly, and don't use acid or corrosive cleaners.
- Wipe off dust and stains on the frame, front panel and belt. Do not wipe backside of the belt.
- After using for a period, dust and stains may appear on the back part, that is normal situation, and just clean them up.

2. Adjust the belt

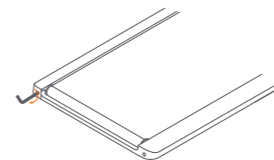

- Press and hold both Mode Switch Button and Acceleration Button on the remote control over 3 seconds.
- The walking belt will move at the speed of 4 km/hr (2.5 mi/hr).
- If belt deviates to the left: Turn the left adjusting screw for a half-circle clockwise.
- If belt deviates to the right: Turn the right adjusting screw for a half-circle clockwise.
- If belt is slipping: Turn both left and right adjusting screw for a half-circle clockwise at same time.
- Keep the machine running for 1-2 minutes and check whether it needs to readjust.

3. Lubricate the Belt

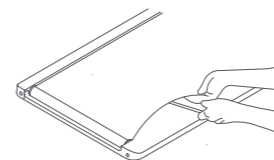

- Turn off the machine and unplug the power cord.
- Lift up the belt and apply silicone oil on the backside of the belt.
- Turn on the machine again
- Keep the machine running under 4 km/hr (2.5 mi/hr) for 10-20 20 seconds.
- Only apply 5 ml ~ 10 ml lubricant oil each time, too much lubricant oil makes the belt become slipping.
- Apply for silicone oil once every 3 months.

07 Trademark and Legal Declaration

Beijing Kingsmith Technology Co., Ltd holds the patents of Walkingpad Walking Device series products. Kingsmith edits and owns the copyright of this manual book. Without Kingsmith's written permission, any form of unauthorized distribution, reproduction, publication, release or quotation by any institution or individual is prohibited. This manual contains as many as possible of all the functions and instructions for use. However, due to product imperfections, design changes, etc., the description may still have discrepancies with what you have purchased. In view of product updates, description in this manual book may differ from what you have purchased in color, appearance, etc. Actual supplies prevail. This appliance is not intended for persons (including children) with reduced physical, sensory or mental capabilities, or lack of experience and knowledge, unless they have been given supervision or instruction concerning use of the appliance by a person responsible for their safety. Children should be supervised to ensure that they do not play with the appliance. Children aged from 8 years and above and persons can use this appliance with reduced physical, sensory or mental capabilities or lack of experience and knowledge if they have been given supervision or instruction concerning use of the appliance in a safe way and understood the hazards involved. Children shall not play with the appliance. Cleaning and user maintenance shall not be made by children without supervision.

Product performance standard : Q/FTSMS0001-2017

08 Replacement and Disposal



The battery contained in this appliance must be removed for or disposal.

When replacing the battery, use only original battery, available from the parts shop.

The battery can be replaced by open the back cover, be aware of the polar mark while inserting a new battery.

Never dispose of old battery in domestic garbage, but only through the proper public collection points. This also applies to the battery of defective appliances.

08 Replacement and Disposal



Devices marked with this symbol must be disposed of separately from your household waste, as they contain valuable materials which can be recycled. Proper disposal protects the environment and human health. Your local authority or retailer can provide information on the matter.